

# MEGAPIX®

IP Cameras

## DWC-INTCAM02

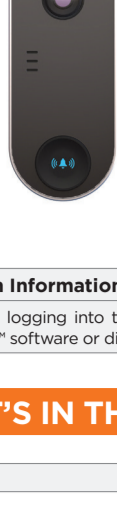

### Default Login Information: admin | admin

A new password must be set when logging into the camera for the first time. This can be done using the DW® IP Finder™ software or directly from the camera's web page.

## WHAT'S IN THE BOX

|   |  |
|---|--|
| Quick Setup Guide                                 |  |
| Tilting Adapter Bracket                           |  |
| Sun Shield Cover                                  |  |
| Mounting Template                                 |  |
| Cables  |  |
| Accessories Bag for Door Station Installation     | 2x Tapping Screws (4x25mm) and Anchors (6x29mm)<br>1x Set Mounting Plate and Lock Screw (4x9mm)<br>1x L-Wrench 5/64" (2mm)<br>1x Back Panel Cover and 2x Screws (2x5mm)<br>1x Set Waterproof Cap |
| Accessories Bag for Tilting Adapter Installation  | 2x Tapping Screws (4x25mm) and Anchors (6x29mm)<br>2x Tilting Screws (4x8mm)   |
| Accessories Bag for Sun Shield Cover Installation | 2x Tapping Screws (4x25mm) and Anchors (6x29mm)<br>1x L-Wrench 5/64" (2mm)<br>1x Lock Screw (4x9mm)<br>3x Base Plate Screws (4x8mm)<br>1x Sun Shield Screw (3x5mm)                               |

### NOTE: Download all your support materials and tools in one place

- Go to: <http://www.digital-watchdog.com/resources>
- Search your product by entering the part number in the 'Search by Product' search bar. Results for applicable part numbers will populate automatically based on the part number you enter.
- Click 'Search'. All supported materials, including manuals and quick start guide (QSGs) will appear in the results.

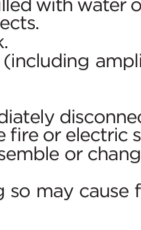

**Attention:** This document is intended to serve as a quick reference for the initial set-up. It is recommended that the user read the entire instruction manual for complete and proper installation and usage.

## SAFETY AND WARNING INFORMATION

Read through this Installation Guide carefully before installing the product. Keep the Installation Guide for future reference. See the user manual for more information on the proper installation, use and care of the product. These instructions are intended to ensure that users can use the product correctly to avoid danger or property loss. Warnings: Serious injury or death may occur if any of the warnings are neglected. Cautions: Injury or equipment damage may occur if any of the cautions are neglected.

### WARNING

- In the use of the product, you must be strict compliance with the electrical safety regulations of the nation and region. When the product is mounted on a wall or ceiling, the device shall be firmly fixed.
- Be sure to use only the standard adapter specified in the specification sheet. Using any other adapter could cause fire, electrical shock, or damage to the product.
- Make sure the power supply voltage is correct before using the camera.
- Incorrectly connecting the power supply or replacing the battery may cause an explosion, fire, electric shock, or damage to the product.
- Do not connect multiple cameras to a single adapter. Exceeding the capacity may cause excessive heat generation or fire.
- Securely plug the power cord into the power source. An insecure connection may cause a fire.
- When installing the camera, fasten it securely and firmly. A falling camera may cause personal injury.
- Do not install in a location subject to elevated temperature, low temperature, or high humidity. Doing so may cause fire or electric shock.
- Do not place conductive objects (e.g. screwdrivers, coins, metal items, etc.) or containers filled with water on top of the camera. Doing so may cause personal injury due to fire, electric shock, or falling objects.
- Do not install in humid, dusty, or sooty locations. Doing so may cause fire or electric shock.
- Do not install near any heat sources such as radiators, heat registers, or other products (including amplifiers) that produce heat.
- In the use of direct sunlight and heat radiation sources. It may cause a fire.
- Do not block any ventilation openings. Install following the manufacturer's instructions.
- If any laser equipment is used near the product, make sure the surface of the sensor is not exposed to the laser beam as that may damage the sensor module.
- If this product does not operate normally, contact the nearest service center. Never disassemble or change this product in any way.
- When cleaning the product, do not spray water directly onto parts of the product. Doing so may cause fire or electric shock.

### CAUTION

- Use proper safety gear when installing and wiring the product.
- Do not drop objects on the product or apply strong shock to it. Keep away from a location subject to excessive vibration or magnetic interference.
- Do not use this product near water.
- The product shall not be exposed to dripping or splashing and no objects filled with liquids, such as vases, shall be placed on the product.
- Avoid aiming the camera directly towards extremely bright objects such as the sun, as this may damage the image sensor.
- The Main plug is used as a disconnect device and shall stay readily operable at any time.
- Remove the power adapter from the outlet when there is lightning. Neglecting to do so may cause fire or damage to the product.
- Do not block any ventilation openings. Install following the manufacturer's instructions.
- A polarized or grounding-type plug is recommended for this product. A polarized plug has two blades with one wider than the other. A grounding-type plug has two blades and a third grounding prong. If the provided plug does not fit into your outlet, consult an electrician for replacement.
- Protect the power cord from being walked on or pinched particularly at plugs, convenience receptacles, and the point where they exit from the product.
- Keep out of direct sunlight and smoke come from the unit, stop using the product at once. Immediately disconnect the power source and contact the service center. Continued use in such a condition may cause fire or electric shock.
- If you want to move the already installed product, be sure to turn off the power and then move or reinstall it.
- Proper configuration of all passwords and other security settings is the responsibility of the installer and/or end-user.
- If cleaning is necessary, please use a clean cloth to wipe it gently. If the device will not be used for a long time, please cover the lens cap to protect the device from dirt.
- Do not touch the camera's lens or sensor module with fingers. If cleaning is necessary, please use a clean cloth to wipe it gently. If the device will not be used for a long time, please cover the lens cap to protect the device from dirt.
- Use only attachments/accessories specified by the manufacturer.
- Always use hardware (e.g. screws, anchors, bolts, locking nuts, etc.) compatible with the mounting surface and of sufficient length and construction to ensure a secure mount.
- Use only with cart stand, tripod, bracket, or table specified by the manufacturer, or sold with the product.
- Unplug this product when a cart is used. Use caution when moving the cart/product combination to avoid injury from tip-over.
- Refer all servicing to qualified service personnel. Servicing is needed when the product has been damaged in any way, such as power supply cord or plug is damaged, liquid has been spilled or objects have fallen into the product, the product has been exposed to rain or moisture, does not operate normally, or has been dropped.

## STEP 1 - PREPARING THE CAMERA

- Using the mounting template, mark and drill the holes marked 'A' in the mounting surface.
- Secure the mounting plate onto the mounting surface using the machine screws and anchors included with the camera.

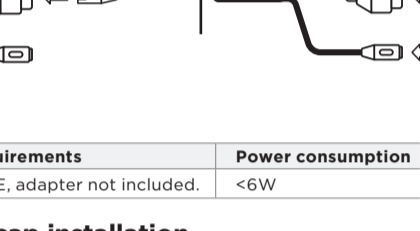

## STEP 2 - POWERING THE CAMERA

Pass the wires through and make all necessary connections.

Use a PoE Switch or PoE Injector to connect data and power to the camera using a single Ethernet cable.

Use a non-PoE Switch to connect data using an Ethernet cable and use a power adapter to power the camera.

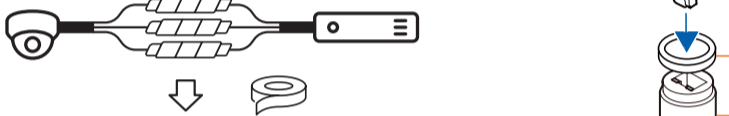

| Power requirements                 | Power consumption |
|------------------------------------|-------------------|
| DC 12V, PoE, adapter not included. | <6W               |

### Waterproof cap installation.

**NOTE:** Use an outdoor-rated sealer in extreme environments.

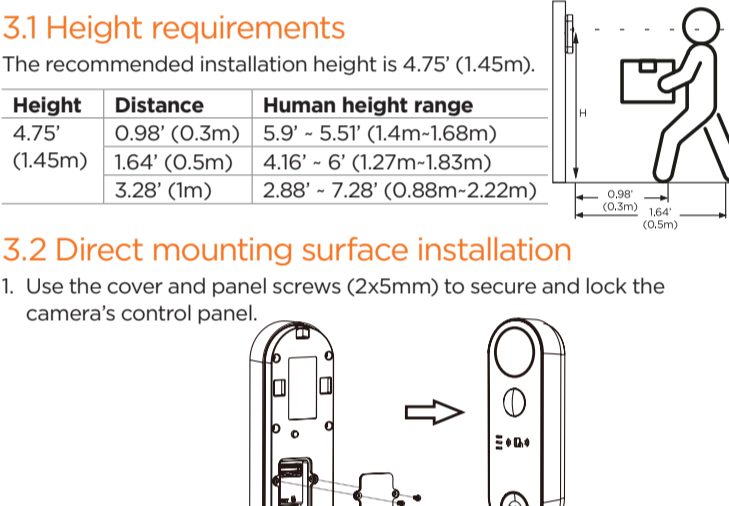

## STEP 3 - INSTALLING THE CAMERA

### 3.1 Height requirements

The recommended installation height is 4.75' (1.45m).

| Height        | Distance     | Human height range          |
|---------------|--------------|-----------------------------|
| 4.75' (1.45m) | 0.98' (0.3m) | 5.9' - 5.51' (1.4m-1.68m)   |
|               | 1.64' (0.5m) | 4.16' - 6' (1.27m-1.83m)    |
|               | 3.28' (1m)   | 2.88' - 7.28' (0.88m-2.22m) |

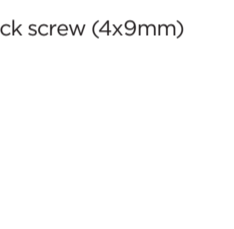

### 3.2 Direct mounting surface installation

- Use the cover and panel screws (2x5mm) to secure and lock the camera's control panel.

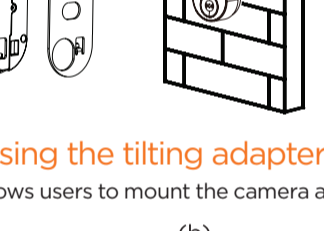

- Attach the camera to the mounting plate using the lock screw (4x9mm) and L-wrench included with the camera.

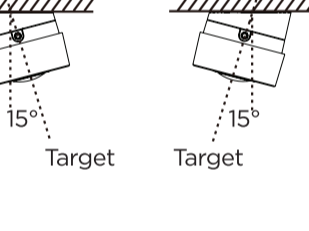

### 3.3 Installation using the tilting adapter

The adapter bracket allows users to mount the camera at a 15° angle.

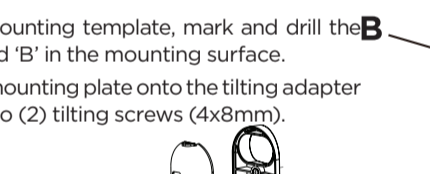

- Using the mounting template, mark and drill the holes marked 'B' in the mounting surface.

- Secure the mounting plate onto the tilting adapter using the two (2) tilting screws (4x8mm).

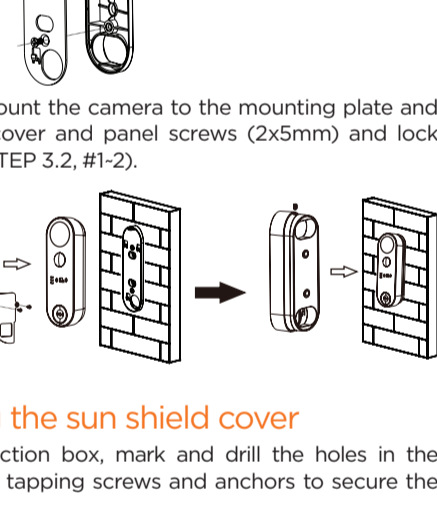

- Pass wires through and mount the camera to the mounting plate and tilting adapter using the cover and panel screws (2x5mm) and lock screw (4x9mm). (Repeat STEP 3.2, #1-2).

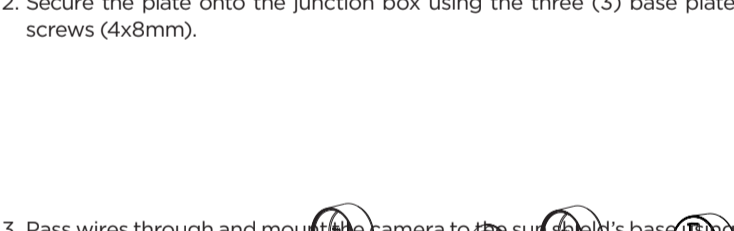

### 3.4 Installation using the sun shield cover

- Using the sun shield's junction box, mark and drill the holes in the mounting surface. Use the tapping screws and anchors to secure the junction box.

- Secure the plate onto the junction box using the three (3) base plate screws (4x8mm).

- Pass wires through and mount the camera to the sun shield's base using the cover and panel screws (2x5mm) and lock screw (4x9mm). (Repeat STEP 3.2, #1-2).

- Secure the sun shield external cover to the camera using the screw (3x5mm).

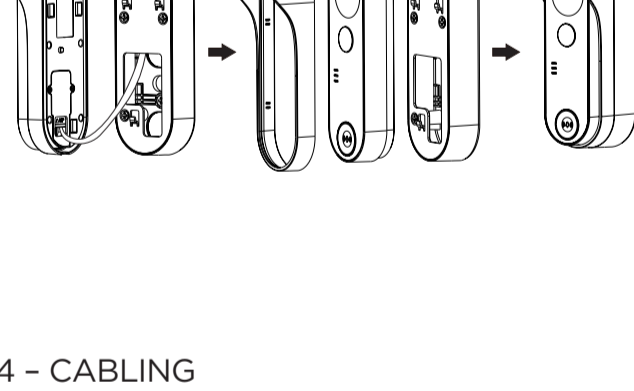

## STEP 4 - CABLING

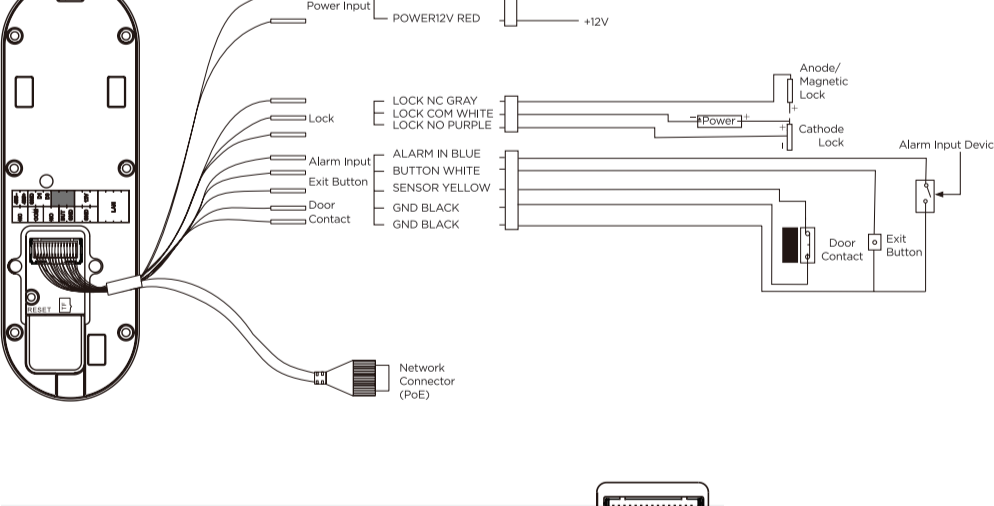

### Resetting the camera:

Press the reset button in the camera's control panel for five (5) seconds to initiate a reset of all the settings, including network settings.



## STEP 5 - SD CARD (OPTIONAL)

- Remove the control panel cover in the back of the camera.
- Insert class 10 SD/SDHC/SDXC card into the SD card slot (max 256GB).
- Press the card inward until it clicks to release from the card slot.

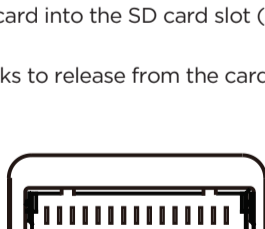

## STEP 6 - WEB VIEWER



The GUI display may differ depending on the camera model.

- Find the camera using the DW IP Finder.
- Double-click on the camera's view in the results table.
- Press the 'Website' button. The camera's web viewer will open up in your default web browser.
- Enter the camera's username and password you set up in the DW IP Finder. If you did not set up a new password with the DW IP Finder, a message will direct you to set up a new password for the camera before gaining access.



To open the camera using the web browser:

- Enter a web browser.
- Enter the camera's IP address and port in the address bar. Example: <http://<ipaddress>:<port>>. Port forwarding may be necessary to access the camera from a different network. Contact your network administrator for more information.
- Enter the camera's username and password you set up in the DW IP Finder.

**NOTE:** Please see the full product manual for web viewer setup, functions and camera settings options.

**NOTE:** This products is covered by one or more claims of the HEVC Patents listed at [patentlist.accessadvance.com](http://patentlist.accessadvance.com).

